

963352 963351 963351 963351 963352

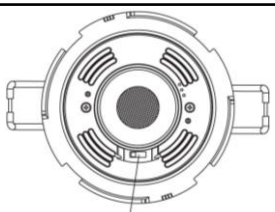

CCT: 2700K – 3000K – 4000K

① Temporisation avant extinction:
10s – 10min

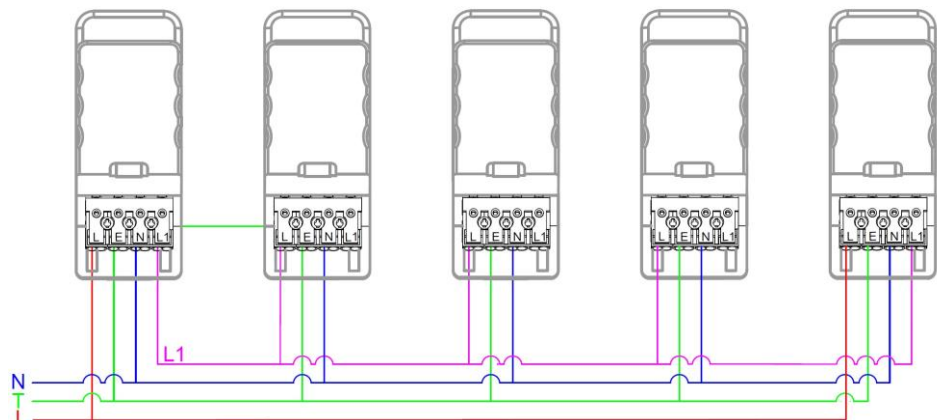
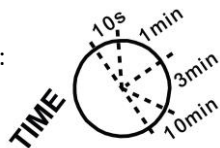

② Sensibilité:
0.1m – 2m



③ Crépusculaire:
S'allume seulement le jour
S'allume seulement le jour et la nuit
S'allume seulement la nuit

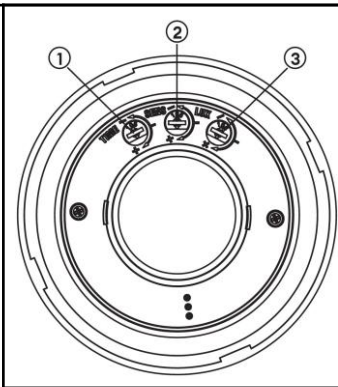
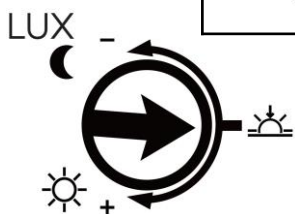

V1.1 - 04.24

resistex

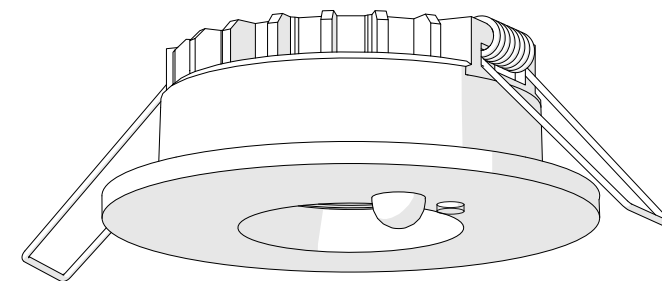
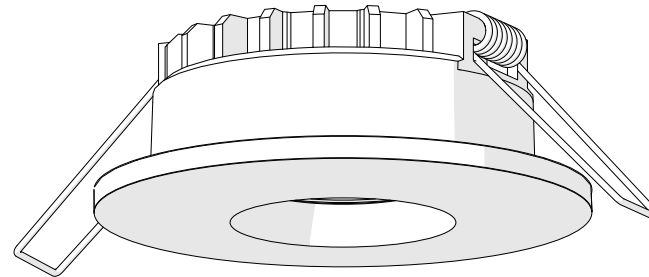

Astario

FR Notice d'installation

EN Installation Instructions

Consignes de sécurité

- Ne travaillez jamais sur le luminaire lorsque celui-ci est sous tension.
- L'installation doit être réalisée par un installateur professionnel dans le respect des normes et des réglementations portant sur les installations électriques.
- Risque de décharges électrostatiques. (Norme ESD). Manipuler en prenant les précautions nécessaires.
- Veuillez respecter les indications et les étapes de montage.



Entretien

- Ne pas utiliser de produits chimiques ou abrasifs pour nettoyer le luminaire.
- Veuillez conserver ce manuel d'installation pour la dépose ou pour les travaux de maintenance ultérieurs. Vous pouvez consulter des informations complémentaires concernant les luminaires RESISTEX sur le site internet www.Resistex-sa.com.



Safety notes

- Never work when voltage is present on the luminaire.
- The installation must be performed by a professional installer in compliance with the standards and regulations relating to electrical installations
- Risk of electrostatic discharges. (ESD Norm). Handle with precautions.
- Please observe the notes and steps described in the mounting instructions.



Maintenance instructions

- Do not use chemicals or abrasives products to clean the fixture.
- Keep these instructions for dismantling or future maintenance. You can consult additional information about RESISTEX luminaires on the website www.resistex-sa.com.



RESISTEX cannot be responsible for any misuse of the product.

www.resistex-sa.com

RESISTEX EXPLOITATION, 11 Quai de la Banquière CS 80010, 06730 Saint-André-de-la-Roche – France

Tél. 04 93 276 276 - Fax 04 93 276 280 - contact@resistex-sa.com

APE 2740Z - Siret 487 593 477 00010 - SAS CAPITAL 649979 € - T.V.A. F.R. 73 487 593 477



